



WATER-POWERED CHEMICAL INJECTORS FOR

Indoor Growers



DOSATRON®

WATER POWERED DOSING TECHNOLOGY

Here's How It Works

Dosatron water-powered dosers are volumetric, they compensate for flow and pressure changes providing consistent, repeatable results.

- Water-powered
- Foolproof operation
- Easy-to-adjust dosage rates
- Simple to maintain saving you time and effort

Our Injectors are Great For:

- Fertilizers
- Supplements
- Stimulants
- Organics
- Compost Tea
- Beneficials
- pH Up/Down
- Fungicides
- Insecticides
- Sanitizers
- Peracetic Acid (PAA)

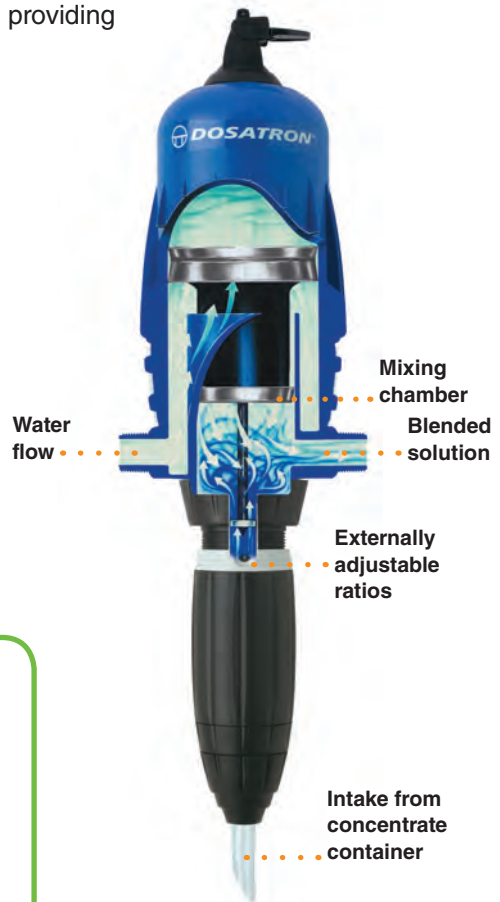

Scan the QR code to see how it works



800-523-8499

Dosatron Injectors

From Flowers to Food

Creating the right nutrient mix for your hydroponic growing operations is a delicate science. With Dosatron's full line of injectors, you can automate your process to create fine-tuned, multi-chemical mixes with repeatable results, every time!

They are water-powered so no electricity is needed and compared to other dosing products on the market, they are easy to maintain and keep in service — saving you time and money.

Dosatron Fertilizer Injectors:

- Easily automate the nutrient blending process
- Deliver precise results, every time
- Eliminate the need for messy reservoirs
- Are simple to use and maintain
- Can be installed in series installations to inject multiple nutrients in a single water line





D25RE09
with bypass
(3.5 to
35 mL/gal)



Scan the QR code for more on hydroponics



Dosatron Injectors



ALL PURPOSE FERTILIZER INJECTORS		
MODEL	D25F1	D25RE09
MAX. FLOW	11 GPM	11 GPM
MIN. FLOW	0.05 GPM	0.05 GPM
INJECTION PERCENTS	1%	0.1% - 0.9%
INJECTION RATIO	1:100 Fixed	1:1000 - 1:112
INJECTION RANGE	7.5 tsp/gal	3.5 to 35 mL/gal
PRESSURE RANGE	4.3 - 85 PSI	4.3 - 85 PSI
CONNECTIONS	3/4" NPT	3/4" NPT



Bypass Switch
Suggested for easy on/off operation!

ALL PURPOSE FERTILIZER INJECTORS			
MODEL	D14MZ2	D14MZ10	D14MZ3000
MAX. FLOW	14 GPM	14 GPM	14 GPM
MIN. FLOW	0.05 GPM	0.05 GPM	0.05 GPM
INJECTION PERCENTS	0.2% - 2%	1% - 10%	0.03% - 0.3%
INJECTION RATIO	1:500 - 1:50	1:100 - 1:10	1:3000 - 1:333
INJECTION RANGE	7.5 to 75 mL/gal	8 to 76 tsp/gal	1.5 to 12 mL/gal
PRESSURE RANGE	4.3 - 85 PSI	7 - 85 PSI	4.3 - 85 PSI
CONNECTIONS	3/4" NPT	3/4" NPT	3/4" NPT

Dosatron dosers have a maximum temperature of 104°F and the bypass is recommended for easy on and off operation.

800-523-8499

ALL PURPOSE FERTILIZER INJECTORS			
MODEL	D45RE15	D8RE2	D8RE5
MAX. FLOW	20 GPM	40 GPM	40 GPM
MIN. FLOW	0.4 GPM	2.2 GPM	2.2 GPM
INJECTION PERCENTS	0.2% - 1.5%	0.2% - 2%	1% - 5%
INJECTION RATIO	1:500 - 1:66	1:500 - 1:50	1:100 - 1:20
INJECTION RANGE	7.5 to 66 mL/gal	7.5 to 75 mL/gal	7.5 to 38 tsp/gal
PRESSURE RANGE	7 - 70 PSI	2 - 110 PSI	2 - 110 PSI
CONNECTIONS	1" NPT	1 1/2" NPT	1 1/2" NPT

ALL PURPOSE FERTILIZER INJECTORS		
MODEL	D8RE3000	D20S
MAX. FLOW	40 GPM	100 GPM
MIN. FLOW	2.2 GPM	5 GPM
INJECTION PERCENTS	0.03% - 0.125%	0.2% - 2%
INJECTION RATIO	1:3000 - 1:800	1:500 - 1:50
INJECTION RANGE	1.25 to 7.5 mL/gal	7.5 to 75 mL/gal
PRESSURE RANGE	2.2 - 116PSI	2 - 120 PSI
CONNECTIONS	1 1/2" NPT	2" NPT

- All Units Include:**
- Mounting bracket
 - Suction hose
 - Weighted strainer
 - Quick start-up guide

Installations

Irrigation Boom

Mounted Dosatron installation onto boom.

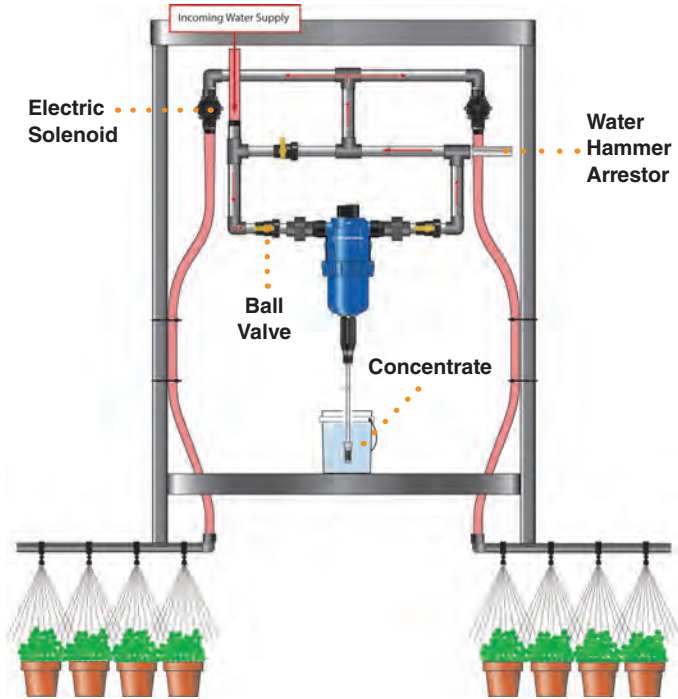

Aeroponics

Dosatron delivers the perfect nutrient solution, even in low-flow systems.

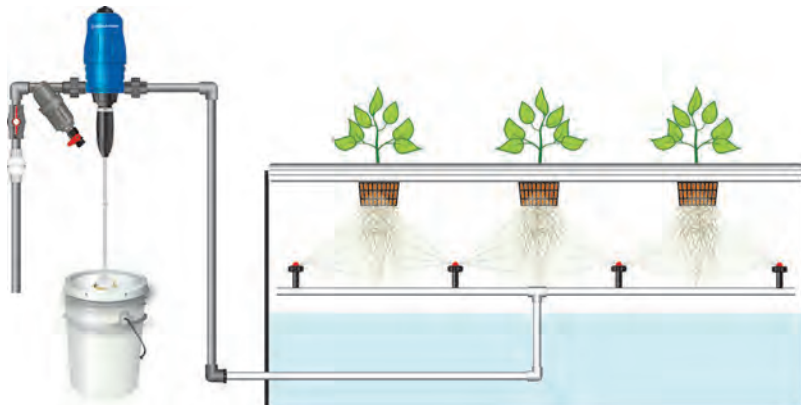

800-523-8499

Multiple Stock Tanks

Dosatrons are the perfect fit for the multi-nutrient feeding programs.

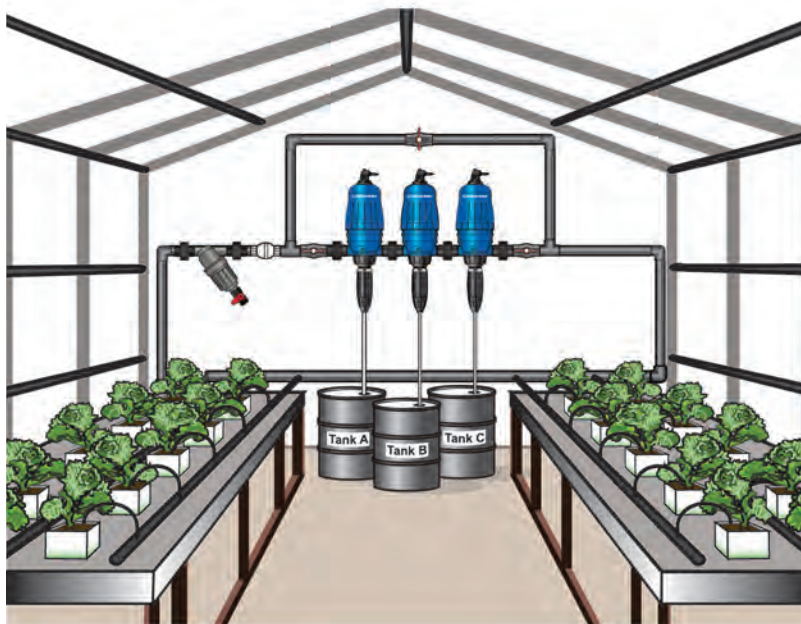

Grow Towers

Set up your Grow Towers using an in-series Dosatron installation.

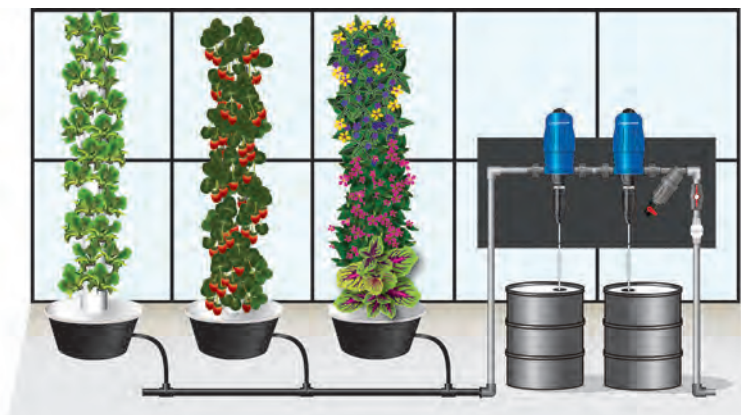

Nutrient Delivery System

The Nutrient Delivery System was developed based on the feedback we received from you, the grower. It provides increased quality, along with making the process of blending and dispensing nutrients easier and more accurate.

Benefits of the Dosatron System

- Used to accurately fill reservoirs or in a drain to waste system — eliminating the need to measure and pour
- Easy to adjust the amount of nutrient being dispensed — simply turn the dial to set the necessary dosage rate
- Designed to perform in both indoor and outdoor environments
- Precise nutrient management will save you money by eliminating waste and increasing yields
- Simple and inexpensive to maintain — easy to use

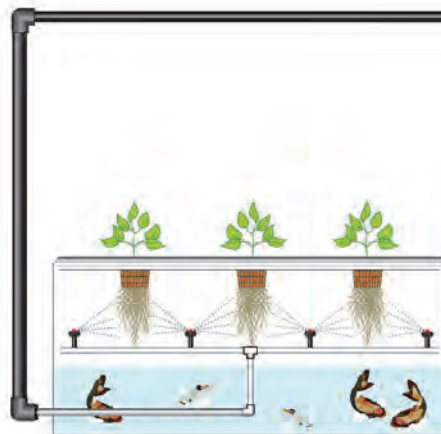
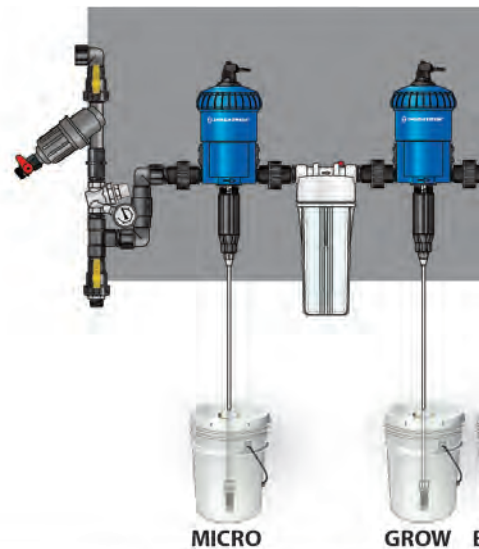

AQUAPONICS



DRIP IRRIGATION

800-523-8499

Nutrient Delivery System Kits Work with Various Substrates and Irrigation Methods

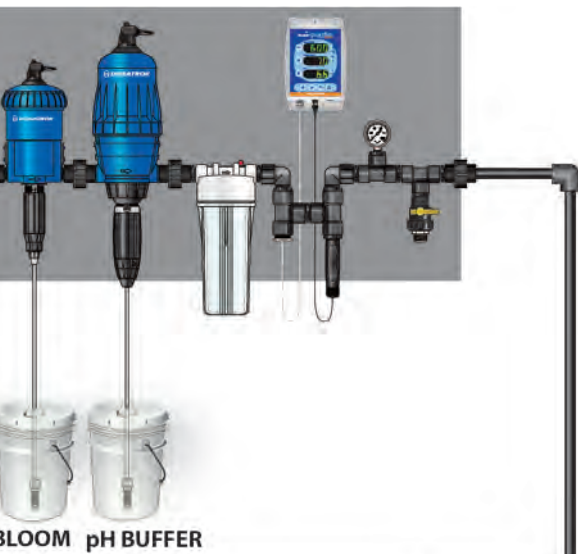

BLOOM pH BUFFER

Other installation options include:

- Grow Towers
- Aeroponics
- Greenhouse
- Rooftop
- Portable Cart

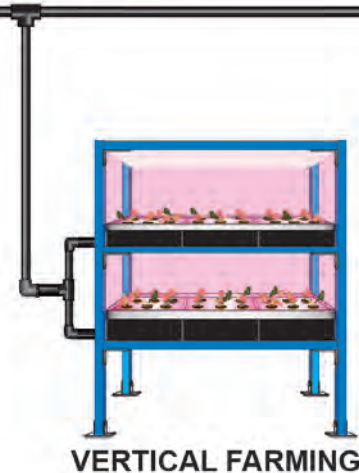

VERTICAL FARMING

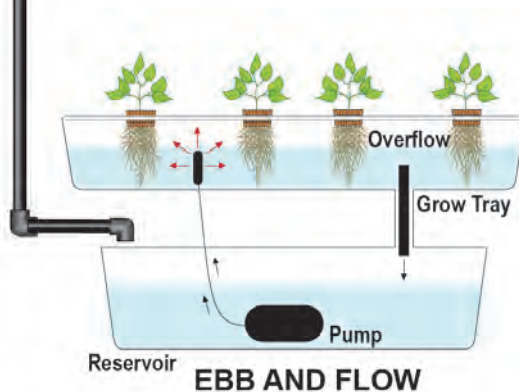

Reservoir

EBB AND FLOW

Nutrient Delivery System Kits

The Nutrient Delivery System is a simplistic system made up of three main panel sections which can be arranged to accommodate a wide variety of fertigation programs. With total control in mind, customizing the entire panel is easy based on your personal nutrient program!

Simple to set up • Maintain • Operate

- 1 It's divided into three kits:

Starter Kit — It includes all the parts you need to get started, from ball valves to Teflon® tape.

Part #: HYKSTART

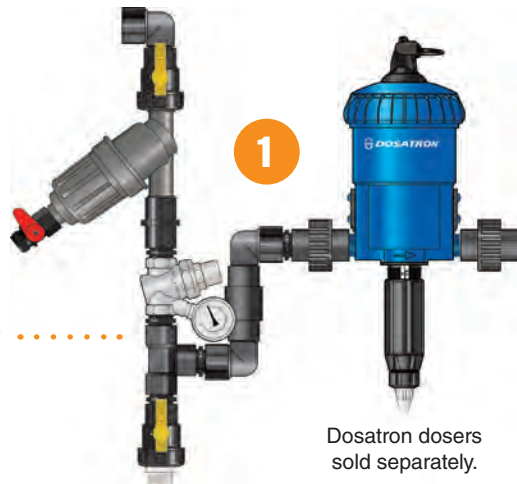

This modular system allows for the use of up to **8 different nutrients, additives, or supplements** along with a pH adjuster - all in one well blended solution.

“ Let “measure and pour”
be a thing of the past.
Save time and money! ”

800-523-8499

- 2** **Mixing Chamber Kit** — Enhances blending as the solution passes through.

Part #: HYKMC34



2

- 3** **Monitor Kit** — Includes a special in-line nutrient monitor that measures and displays your well-blended outgoing solution. No more guess work involved in feeding your plants!



Part #: HYKMON

The Nutrient Delivery System thrives anywhere, from greenhouse environments to outdoors, allowing it to be installed in any application. And, by automating the nutrient delivery process it accurately dispenses the desired solution. This makes the time draining practice of “measure and pour” a thing of the past, saving you time and money!

Accessories

In-Line Pressure Booster Pump

The low pressure booster pump is an ideal accessory to help increase your low pressure by an average 40 PSI.

Part #: X500-109

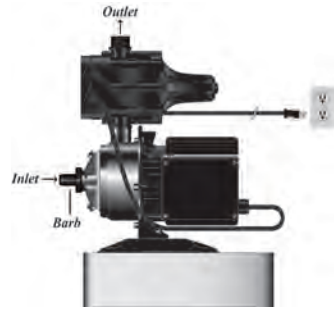

Constant In-Line Nutrient Solution Monitor

Provides 24-hour continuous in-line reading for pH, conductivity, and temperature within your nutrient solution.

Part #: X500-105



800-523-8499

Nutrient Dosing Calculation Sheet

Desired Dosage Concentration		Doser Setting(s)		IF DILUTING THE STOCK TANK, HERE IS THE NEW DOSER SETTING:						
ml/gallon (milliliters)	tsp/gallon (teaspoons)	Set % to:	Set ratio to:	100% Additive	75% Additive 25% H2O	50% Additive 50% H2O	25% Additive 75% H2O	15% Additive 85% H2O	5% Additive 95% H2O	1% Additive 99% H2O
1	0.2	0.026	3750	-	0.04%	0.05%	0.11%	0.18%	0.53%	2.64%
1.25	0.25	0.03	3000	0.03%	0.04%	0.07%	0.13%	0.22%	0.66%	3.30%
2	0.4	0.05	2000	0.05%	0.07%	0.11%	0.21%	0.35%	1.06%	5.28%
3	0.6	0.08	1250	0.08%	0.11%	0.16%	0.32%	0.53%	1.59%	7.93%
3.5	0.7	0.10	1000	0.10%	0.13%	0.20%	0.40%	0.67%	2.01%	10.05%
4	0.8	0.11	950	0.11%	0.14%	0.21%	0.42%	0.70%	2.11%	-
5	1	0.13	750	0.13%	0.18%	0.26%	0.53%	0.88%	2.64%	-
6	1.2	0.16	625	0.16%	0.21%	0.32%	0.63%	1.06%	3.17%	-
7	1.4	0.18	540	0.18%	0.25%	0.37%	0.74%	1.23%	3.70%	-
7.5	1.5	0.20	500	0.20%	0.26%	0.40%	0.79%	1.32%	3.96%	-
8	1.6	0.21	475	0.21%	0.28%	0.42%	0.85%	1.41%	4.23%	-
9	1.8	0.24	425	0.24%	0.32%	0.48%	0.95%	1.59%	4.76%	-
10	2	0.26	375	0.26%	0.35%	0.53%	1.06%	1.76%	5.28%	-
11	2.2	0.29	350	0.29%	0.39%	0.58%	1.16%	1.94%	5.81%	-
12.5	2.5	0.33	300	0.33%	0.44%	0.66%	1.32%	2.20%	6.60%	-
15	3	0.40	250	0.40%	0.53%	0.79%	1.59%	2.64%	7.93%	-
17.5	3.5	0.46	220	0.46%	0.62%	0.92%	1.85%	3.08%	9.25%	-
20	4	0.53	190	0.53%	0.70%	1.06%	2.11%	3.52%	-	-
25	5	0.66	150	0.66%	0.88%	1.32%	2.64%	4.40%	-	-
30	6	0.79	125	0.79%	1.06%	1.59%	3.17%	5.28%	-	-
34	6.8	0.9	112	0.90%	1.20%	1.80%	3.60%	6.00%	-	-
37.5	7.5	1.0	100	1.00%	1.33%	2.00%	4.00%	6.66%	-	-
50	10	1.3	75	1.32%	1.76%	2.64%	5.28%	8.81%	-	-
75	15	2.0	50	2.00%	2.67%	4.00%	8.00%	-	-	-
190	38	5.0	20	5.00%	6.67%	10.00%	-	-	-	-
375	75	10.0	10	10.00%	-	-	-	-	-	-

Scan the QR code with your smart device to calculate your dilution or visit www.dosatronusa.com and CHAT with us.



Li'l Bud-D DosaCart

Spot Treatments and Drenches

The Li'l Bud-D includes a 5-gallon bucket that is perfect for spot treatments and root drenches. Add the Quick Hook-Up Kit along with either an 11, 14, or 40 GPM Dosatron fertilizer injector and you have the perfect portable setup.



- Polyethylene construction
- 5-gallon bucket with lid
- 10" no flat tires for maximum mobility
- Dimensions: 44.5" H, 19" W and 22" D
- Secured low with a wide base to prevent tipping

..... Part #: HS15-5

Dosatron injector and cart hook-up kit sold separately.

800-523-8499

Sanitizing and Foaming



Add the **Airless Foam Wand** to the Li'l Bud-D 5-gallon cart combination of the Dosatron chemical injector and the Quick Hook-Up Kit and it makes the perfect, portable system for sanitizing applications.

The Airless Foam Wand creates a wet, clinging foam with a 15' to 20' throw to clean those hard-to-reach places.

..... Part #: HS15-5



.....
Part #: X400-113



..... Part #: HOSE58-12FT



.....
Part #: HSPK58
(11 and 14 GPM)





DOSATRON®

WATER POWERED DOSING TECHNOLOGY

2090 Sunnydale Blvd. • Clearwater, FL 33765 • 727-443-5404
800-523-8499 • www.dosatronusa.com

2016-04 PF 2016-176-HORT047