

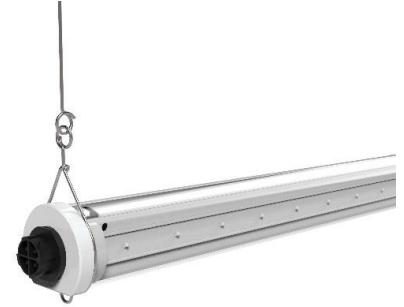

# Integral

## Horticulture LED Lighting System



### BEFORE YOU BEGIN / AVANT DE COMMENCER

Read these instructions completely and carefully. Lisez attentivement ces instructions dans leur intégralité.



### WARNING / AVERTISSEMENT

#### RISK OF ELECTRIC SHOCK

- Turn power off before installation, inspection, cleaning or removal.
- **Do NOT make or break connections under load.**
- Follow appropriate lock out/tag out safety procedure.
- Follow all National Electric Codes (NEC) and local codes.
- This product must be installed in accordance with the applicable installation code by a person familiar with the construction and operation of the product and the hazards involved.
- The installation and associated structures are subject to approval by the authority having jurisdiction.
- Use only with components identified in this document.
- Suitable for dry, damp, and wet locations; Do not immerse any component.
- For commercial or industrial use only.

#### RISK OF FIRE

- The luminaire shall be installed with a minimum of 5 inches between the light module and any highly reflective surface.
- All cables including connectors shall not be concealed or extended through a wall, floor, ceiling, or other parts of the building structure; located above a suspended ceiling or dropped ceiling; permanently affixed to the building structure.
- Cables shall be routed so that they are not subject to strain and are protected from physical damage; visible over their entire length; and used within their rated ampacity as determined for the maximum temperature of the installed environment specified in the instructions.
- Before applying power, ensure that any open female connectors in the installation are sealed with an end cap.
- For safe operation, and to maximize the longevity of the luminaire; ensure that the luminaire is clean and free of dirt, dust, oil, or any other debris. Do not apply any kind of film on the lens or otherwise cover the luminaire in any way.

#### RISQUE DE CHOC ELECTRIQUE

- Coupez l'alimentation avant l'inspection, l'installation ou le déplacement.
- **Ne PAS brancher ou débrancher si le système est sous tension.**
- Suivez la procédure de sécurité appropriée de verrouillage/étiquetage.
- Suivre tous les codes électriques locaux applicables.
- Ce produit doit être installé selon le code d'installation pertinent, par une personne qui connaît bien le produit et son fonctionnement ainsi que les risques inhérents.
- L'installation et les structures associées sont soumises à l'approbation des autorités compétentes.
- Utilisez uniquement avec les composants identifiés dans ce document.
- Convient aux endroits secs, humides et mouillés; Ne doit pas être immergé.
- Pour usage commercial ou industriel seulement.

#### RISQUE D'INCENDIE

- Le luminaire doit être installé avec un minimum de 5 pouces entre le module d'éclairage et toute surface hautement réfléchissante.
- Tous les câbles, y compris les connecteurs, ne doivent pas être dissimulés ou prolongés à travers un mur, un sol, un plafond ou d'autres parties de la structure du bâtiment ; situé au-dessus d'un plafond suspendu ou d'un plafond suspendu ; fixé de façon permanente à la structure du bâtiment
- Les câbles doivent être acheminés de manière à ne pas être soumis à des contraintes et à être protégés des dommages physiques ; visibles sur toute leur longueur ; et utilisés dans leur capacité nominale telle que déterminée pour la température maximale de l'environnement d'installation spécifiée dans les instructions.
- Avant de mettre sous tension, assurez-vous que tous les connecteurs femelles ouverts dans l'installation sont scellés avec un capuchon d'extrémité.
- Pour un fonctionnement sûr et pour maximiser la longévité du luminaire ; assurez-vous que le luminaire est propre et exempt de saleté, de poussière, d'huile ou de tout autre débris. N'appliquez aucun type de film sur la lentille et ne couvrez pas le luminaire de quelque manière que ce soit.

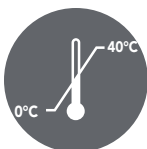

#### Suitable for operation in an ambient temperature between 32°F (0°C) and 104°F (40°C).

A mechanical ventilation or cooling system is required to maintain the temperature within the growing space below 104°F (40°C) when the light module is in operation.

#### Opération compatible avec un environnement à température ambiante contrôlée entre 32°F (0°C) et 104°F (40°C).

L'utilisation d'un système de contrôle de la température sera nécessaire pour garder la serre sous les 104°F (40°C) lorsque le luminaire est en fonction.



## Typical Kit Components

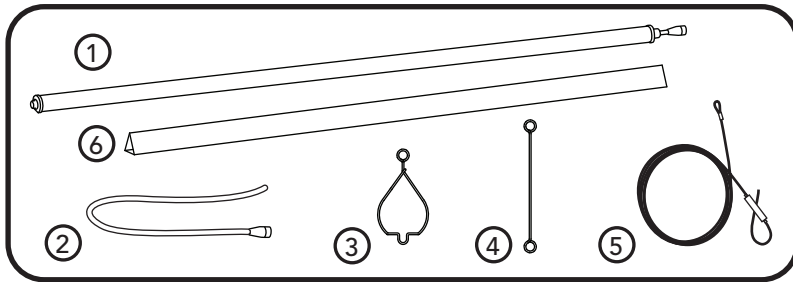

- ① Integral
- ② Leader cable with connector cap (accessory)
- ③ Bracket (2X)
- ④ Hook (2X) (accessory)
- ⑤ Suspension cable (2X) (accessory)
- ⑥ Paper ruler (fold carton using the outlines to create a triangle, then fold the tips into the designated holes)

## Light Module Specifications

CI Code	Part Number	Description	Weight	System Input Current (A)	IEC 62471 Risk Group
*286JUL	VAIS L96 PUR SEFY MVOLT GZN	Verjüre Arize Integral L96 MVOLT PUR	2.5 Kg (5.5 lbs)	120/208/277VAC, 0.85/0.49/0.39A	RG1
*286JUP	VAIS L96 PUR SEFY XVOLT GZN	Verjüre Arize Integral L96 XVOLT PUR	2.5 Kg (5.5 lbs)	277/347/480VAC, 0.36/0.28/0.20A	RG1

## Interconnection Cable Specifications

CI Code	Part Number	Description
*286JVK	VAICNPQDAC21FT	Verjüre Arize Integral Quick Disconnect Cord No Plug AC Only (2 Conductor) 21ft
*286JVL	VAIEX8FT	Verjüre Arize Integral Extension Cable 8ft
*286JVN	VAIEX2FT	Verjüre Arize Integral Extension Cable 2ft
*286JVV	VAIEX1M2F4CD2FT	Verjüre Arize Integral Extension Cable 1 Male to 2 Female Splitter 4 Conductor 2ft
*286JVM	RK8VAI QDAC CONV	Repair Kit Verjüre Arize Integral Quick Converter Cable M25 Female to Wieland Male
*286JW4	RK8VAI QD CAPF	Repair Kit Verjüre Arize Integral Quick Disconnect Cable Cap Female
*286JVP	VAICPQDTL20A L8-20P	Verjüre Arize Integral Cord & Plug Quick Disconnect Twist Lock NEMA L8-20P, 6FT
*286JVS	VAICPQDTL L7-15P	Verjüre Arize Integral Cord & Plug Quick Disconnect Twist Lock NEMA L7-15P, 6FT
*286JVT	VAICPQDSB 5-15P	Verjüre Arize Integral Cord & Plug Quick Disconnect Straight Blade NEMA 5-15P, 6FT

## Mounting Accessories Specifications

SKU	Part Number	Description
*286JVU	VAIAC264	Verjüre Arize Integral Aircraft Cable 264inch (22ft)
*286JVY	VAIMTHK5 J200	Verjüre Arize Integral Mounting Hook 5.66inch
*286JVX	VAIMTHK9 J200	Verjüre Arize Integral Mounting Hook 9.60inch
*286JW7	RK5VAIS MTB J20	Repair Kit Verjüre Arize Integral Mounting Bracket

### ⚠ CAUTION / ATTENTION

Installation instructions and specifications for accessories can be found in the accessory package.

Les instructions d'installation et spécifications pour les accessoires se retrouvent dans le kit d'accessoires.

### Sample Base Installation Diagram

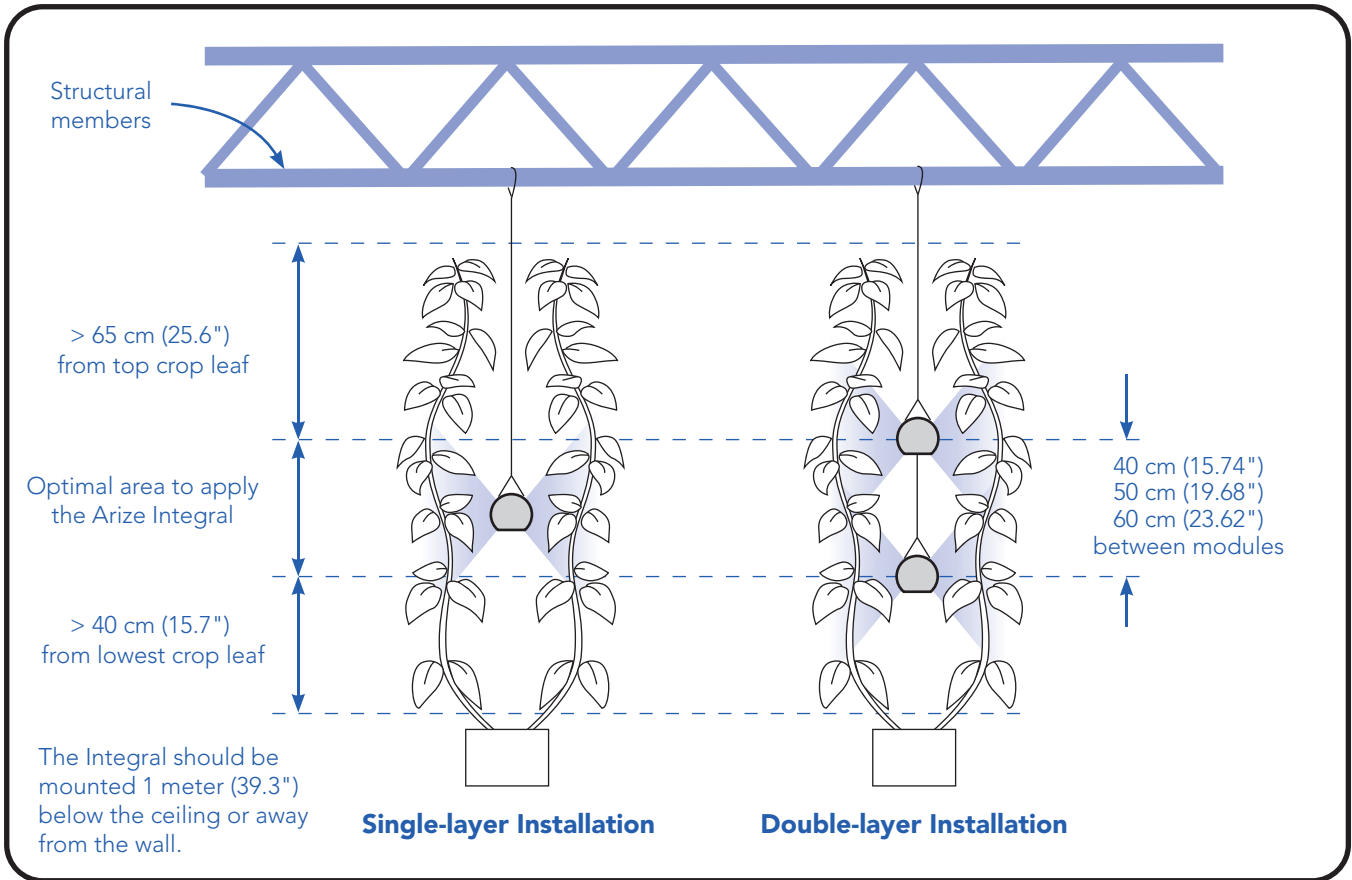

### Wiring Diagrams

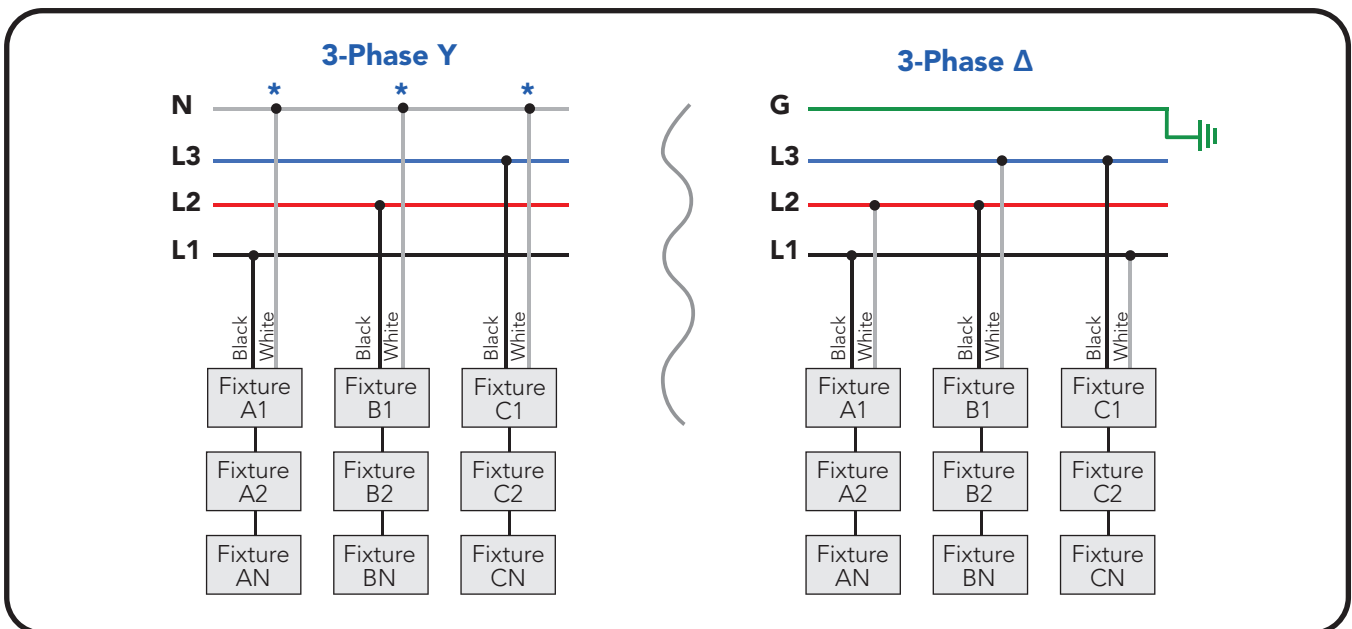

## Install Integral Bracket

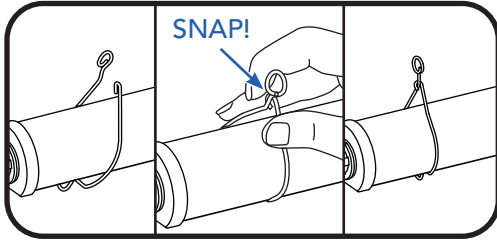

① Put bracket on Integral and push to lock.

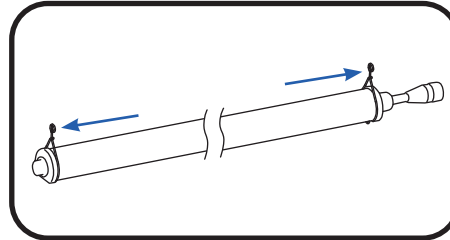

② Slide brackets to end cap.

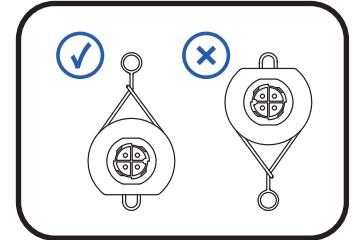

③ Check orientation.

## One-layer Installation to the Mounting Unistrut

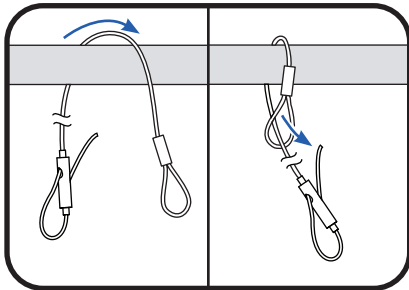

① Wrap loop end of cable over structural member, insert gripper end through loop end.

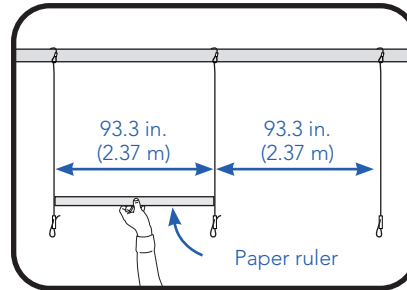

② Use paper ruler gauge to ensure uniform spacing between suspension cables.

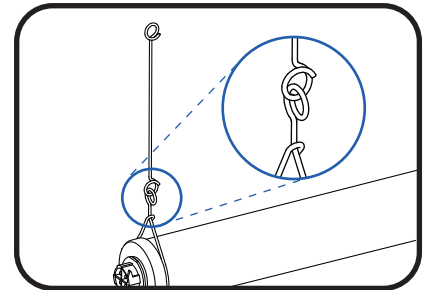

③ Attach a hook to each end bracket.

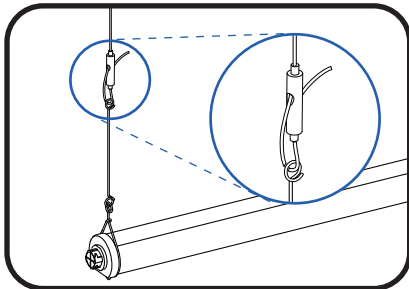

④ Attach hooks to suspension cables. Adjust the height of gripper end to make sure the Integral is horizontal after installation.

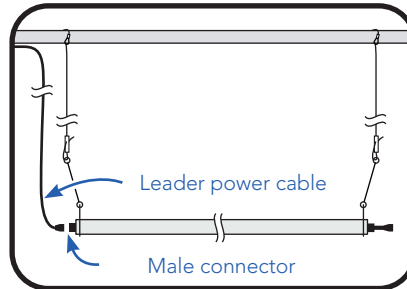

⑤ Hang Integral on suspension cables with male connector facing leader power cable.

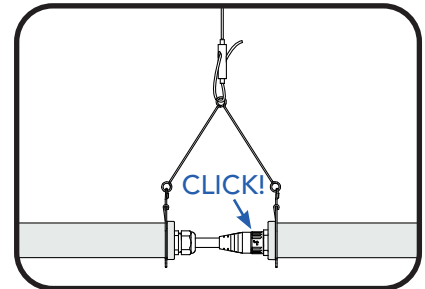

⑥ Repeat steps 3-5 for remaining Integrals. Connect modules together with jumper cable and ensure the male and female connectors are snapped together correctly.

## Maximum Loading of Integral

Model	Voltage (V)	Current (A)	Maximum Run Length (pcs)
VAIS L96 PUR SEFY MVOLT GZN	120	0.85	11
	208	0.49	19
	240	0.43	23
	277	0.39	26
VAIS L96 PUR SEFY XVOLT GZN	277	0.36	26
	347	0.28	33
	480	0.20	46

**CAUTION:** Do not exceed the maximum run length specified in the Maximum Loading table (left).

## Electrical Connections

### ⚠ WARNING / AVERTISSEMENT

**RISK OF ELECTRIC SHOCK OR PRODUCT DAMAGE**  
Turn power OFF before inspection, installation or removal.

**RISQUE DE CHOC ÉLECTRIQUE OU DE DOMMAGE AU PRODUIT**  
Coupez l'alimentation avant l'inspection, l'installation ou la désinstallation.

### Connect AC Input Leader Cable to Integral

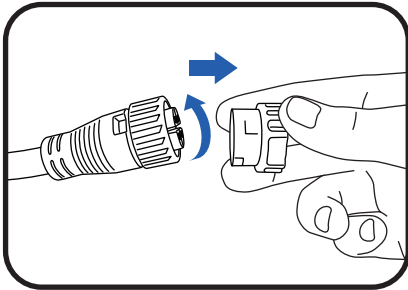

① Rotate and remove the connector cap from the leader cable.

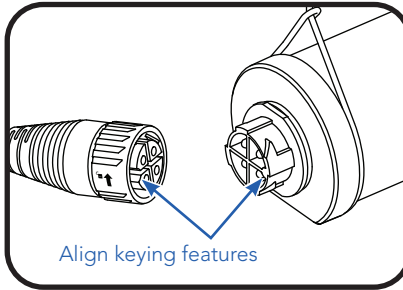

② Align keying features of the male connector on the 1st Integral with female connector on leader cable.

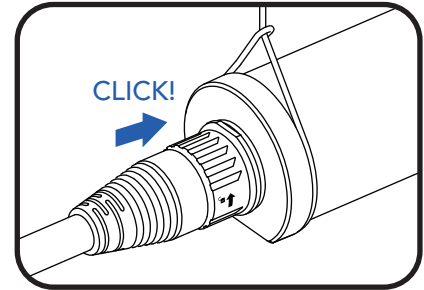

③ Push connectors together until a click is heard.

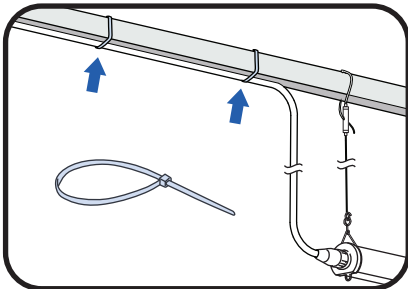

④ Recommended: secure AC input leader cable.

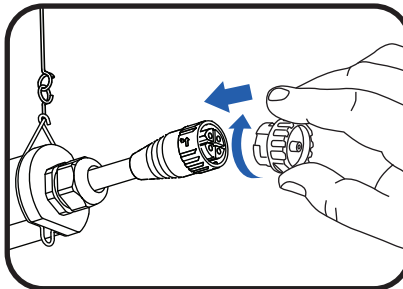

⑤ Put connector cap on the female connector of the last Integral in each chain. Rotate the cap and make sure the cap is installed to female connector to comply to IP66.

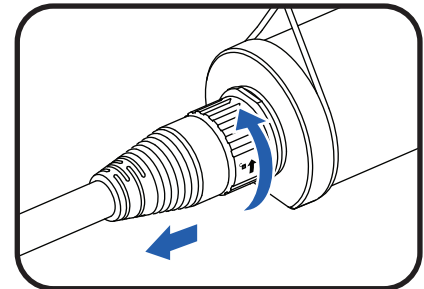

**NOTE:** To disassemble connectors, rotate blue ring and pull to separate connectors.

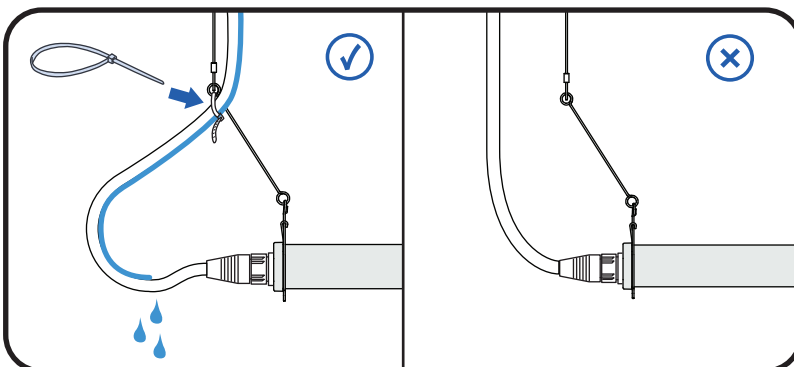

**NOTE:** Relieve the stress from the cable connections by introducing a loop and using cable ties. The lowest point of the power cable should be just below the lowest point of the male connector.

## Connecting to AC Line

### Leader Cable with Open Wire

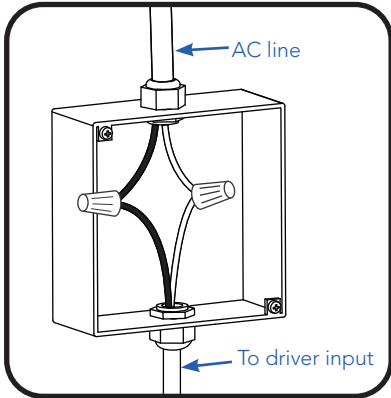

Connect the black wire to Line 1 and white wires to Neutral or Line 2 of the incoming AC line either within a suitable junction box or raceway provided with a suitable strain relief; or by means of a suitably rated plug to a receptacle.

### Leader Cable with NEMA Plug

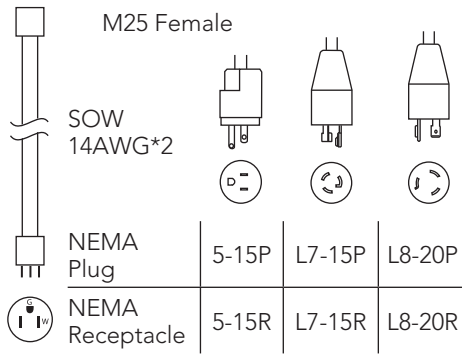

### Leader Cable with Wieland Connector

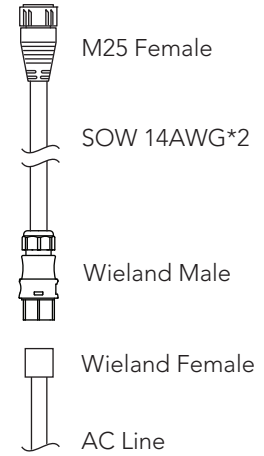

## Configuration When a Central Power Supply is Used

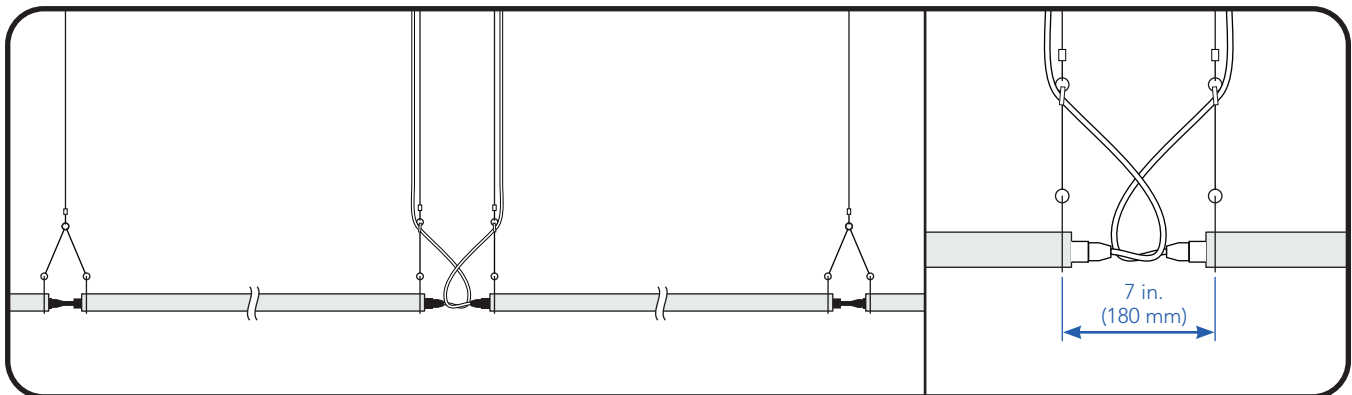

Install the left and right Integral line with their own suspension cables and separate power cables. The horizontal distance between the first suspension cables of both Integral lines must be 180 mm. Follow all previous applicable steps to build and complete both Integral lines.

## Two-layer Installation

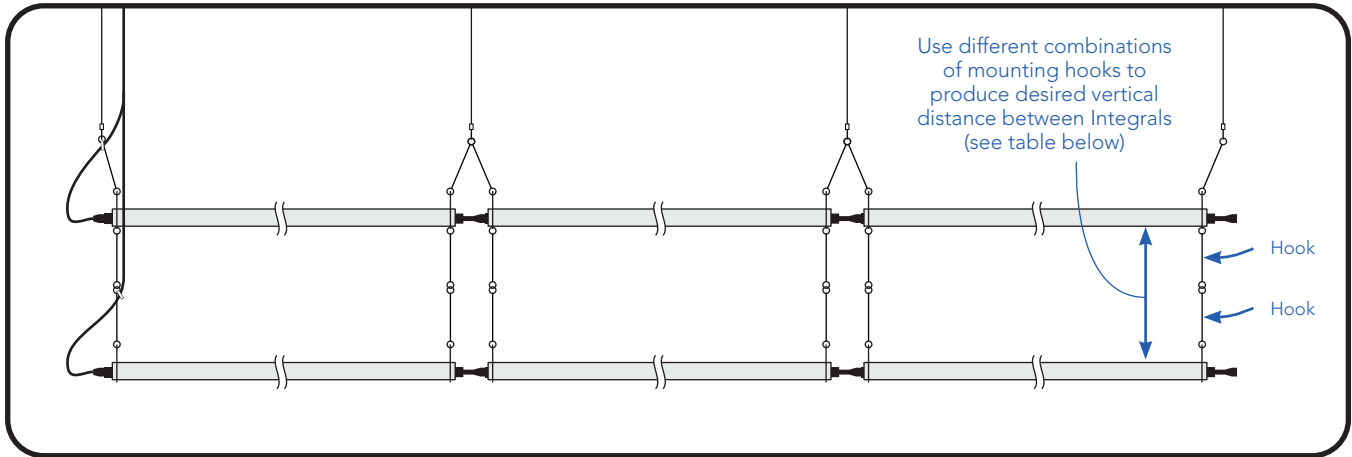

When mounting a second Integral line below the first line, attach hooks to the bottom of the upper line bracket and the top of the lower line bracket. The vertical center to center distance between lines may be customized by choosing different combinations of mounting hooks. Follow all previous applicable steps to build and complete second Integral line. **NOTE:** No more than two lines of Integrals may be suspended from a suspension cable.

Hook Option 1	Hook Option 2	Distance between Integral lines (center to center)
Hook 1 (138 mm/5.43")	Hook 1 (138 mm/5.43")	400 mm (15.74")
Hook 1 (138 mm/5.43")	Hook 2 (238 mm/9.37")	500 mm (19.68")
Hook 2 (238 mm/9.37")	Hook 2 (238 mm/9.37")	600 mm (23.62")

## Save These Instructions

Use only in the manner intended by the manufacturer. If you have any questions, contact the manufacturer.

This device complies with part 15 of the FCC Rules. Operation is subject to the following two conditions: (1) This device may not cause harmful interference, and (2) this device must accept any interference received, including interference that may cause undesired operation.

NOTE: This equipment has been tested and found to comply with the limits for a Class A digital device, pursuant to part 15 of the FCC Rules. These limits are designed to provide reasonable protection against harmful interference when the equipment is operated in a commercial environment. This equipment generates, uses, and can radiate radio frequency energy and, if not installed and used in accordance with the instruction manual, may cause harmful interference to radio communications. Operation of this equipment in a residential area is likely to cause harmful interference in which case the user will be required to correct the interference at his own expense.

This Class [A] RFLD complies with the Canadian standard ICES-005. /CeDEFR de la classe [A] est conforme à la NMB-005 du Canada.



Electrical products must not be thrown out with domestic waste. They must be taken to a communal collecting point for environmentally friendly disposal in accordance with local regulations. Contact your local authorities or stockist for advice on recycling. The packaging material is recyclable. Dispose of the packaging in an environmentally friendly manner and make it available for the recyclable material collection-service.



Horticultural lighting. Not suitable for household illumination.